

SEMITOP[®]3

**3-phase bridge rectifier +
brake chopper + 3-phase
bridge inverter**
SK 30 DGDL 066 ET

Target Data

Features

- Compact design
- One screw mounting
- Heat transfer and isolation through direct copper bonded aluminium oxide ceramic (DCB)
- Trench IGBT technology
- CAL technology FWD
- Integrated NTC temperature sensor

Typical Applications

- Inverter up to 10 kVA
- Typ. motor power 4 kW

Remarks

- $V_{CE,sat}$, V_F = chip level value

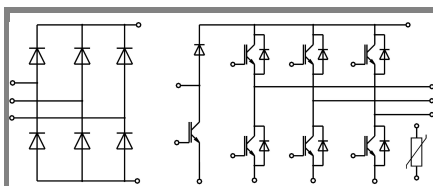

DGDL - ET

Absolute Maximum Ratings		$T_s = 25^\circ\text{C}$, unless otherwise specified	
Symbol	Conditions	Values	Units
IGBT - Inverter, chopper			
V_{CES}		600	V
I_C	$T_s = 25 (70)^\circ\text{C}$, $T_j = 175^\circ\text{C}$	38 (31)	A
I_C	$T_s = 25 (70)^\circ\text{C}$, $T_j = 150^\circ\text{C}$	35 (26)	A
I_{CRM}	$I_{CRM} = 2 \times I_{Cnom}$, $t_p = 1 \text{ ms}$	60	A
V_{GES}		± 20	V
T_j		-40 ... + 175	$^\circ\text{C}$
Diode - Inverter, chopper			
I_F	$T_s = 25 (70)^\circ\text{C}$, $T_j = 150^\circ\text{C}$	32 (24)	A
I_F	$T_s = 25 (70)^\circ\text{C}$, $T_j = 175^\circ\text{C}$	36 (28)	A
I_{FRM}	$I_{FRM} = 2 \times I_{Fnom}$, $t_p = 1 \text{ ms}$	60	A
Diode - Rectifier			
V_{RRM}		800	V
I_F	$T_s = 70^\circ\text{C}$	35	A
I_{FSM}	$t_p = 10 \text{ ms}$, $\sin 180^\circ$, $T_j = 25^\circ\text{C}$	370	A
i^2t	$t_p = 10 \text{ ms}$, $\sin 180^\circ$, $T_j = 25^\circ\text{C}$	680	A^2s
T_j		-40 ... + 175	$^\circ\text{C}$
T_{sol}	Terminals, 10 s	260	$^\circ\text{C}$
T_{stg}		-40 ... + 125	$^\circ\text{C}$
V_{isol}	AC, 1 min.	2500	V

Characteristics		$T_s = 25^\circ\text{C}$, unless otherwise specified			
Symbol	Conditions	min.	typ.	max.	Units
IGBT - Inverter, chopper					
$V_{CE(sat)}$	$I_{Cnom} = 30 \text{ A}$, $T_j = 25 (150)^\circ\text{C}$		1,45 (1,65)	1,85 (2,05)	V
$V_{GE(th)}$	$V_{GE} = V_{CE}$, $I_C = 0,43 \text{ mA}$	5	5,8	6,5	V
$V_{CE(TO)}$	$T_j = 25 (150)^\circ\text{C}$		0,9 (0,85)	1 (0,9)	V
r_{CE}	$T_j = 25 (150)^\circ\text{C}$		18 (27)	28 (38)	m Ω
C_{ies}	$V_{CE} = 25 \text{ V}$, $V_{GE} = 0 \text{ V}$, $f = 1 \text{ MHz}$		1,63		nF
C_{oes}	$V_{CE} = 25 \text{ V}$, $V_{GE} = 0 \text{ V}$, $f = 1 \text{ MHz}$		0,11		nF
C_{res}	$V_{CE} = 25 \text{ V}$, $V_{GE} = 0 \text{ V}$, $f = 1 \text{ MHz}$		0,05		nF
$R_{th(j-s)}$	per IGBT		1,8		K/W
$t_{d(on)}$	under following conditions		15		ns
t_r	$V_{CC} = 300 \text{ V}$, $V_{GE} = -7/+15$		12		ns
$t_{d(off)}$	$I_{Cnom} = 30 \text{ A}$, $T_j = 125^\circ\text{C}$		228		ns
t_f	$R_{Gon} = R_{Goff} = 12 \Omega$		46		ns
$E_{on} (E_{off})$	inductive load		0,55 (1,15)		mJ
Diode - Inverter, chopper					
$V_F = V_{EC}$	$I_F = 30 \text{ A}$, $T_j = 25 (150)^\circ\text{C}$		1,5 (1,5)	1,7 (1,7)	V
$V_{(TO)}$	$T_j = 25 (150)^\circ\text{C}$		1 (0,9)		V
r_T	$T_j = 150 ()^\circ\text{C}$		20		m Ω
$R_{th(j-s)}$	per diode		2,3		K/W
I_{RRM}	under following conditions		19,1		A
Q_{rr}	$I_{Fnom} = 30 \text{ A}$, $V_R = 300 \text{ V}$		1,8		μC
E_{rr}	$V_{GE} = 0 \text{ V}$, $T_j = 125^\circ\text{C}$		0,53		mJ
	$di_F/dt = -950 \text{ A}/\mu\text{s}$				
Diode rectifier					
V_F	$I_{Fnom} = 25 \text{ A}$, $T_j = 25^\circ\text{C}$		1,1		V
$V_{(TO)}$	$T_j = 150^\circ\text{C}$		0,8		V
r_T	$T_j = 150^\circ\text{C}$		15		m Ω
$R_{th(j-s)}$	per diode		1,7		K/W
Temperature Sensor					
R_{ts}	5 %, $T_r = 25 (100)^\circ\text{C}$		5000(493)		Ω
Mechanical Data					
w			30		g
M_s	Mounting torque	2,25		2,5	Nm

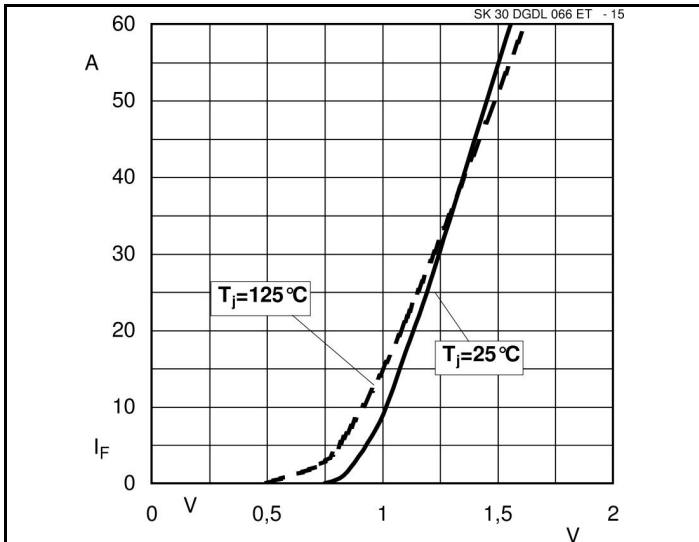

Fig. 15 Input Bridge Diode forward characteristic

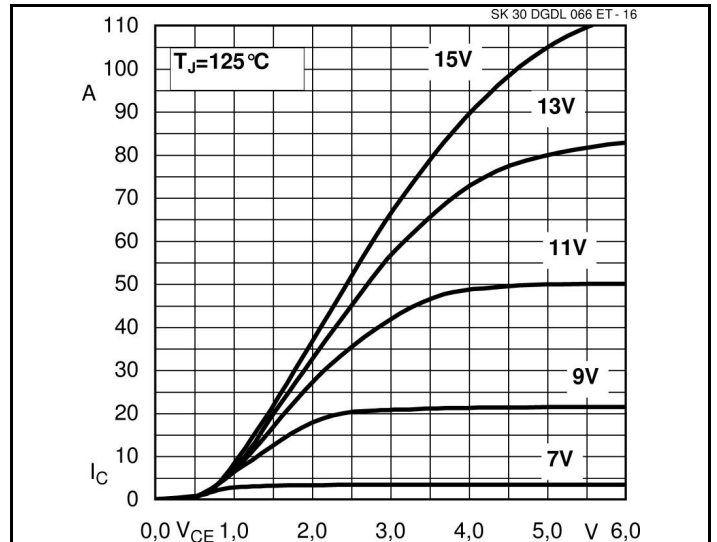

Fig. 16 Typical Output Characteristic

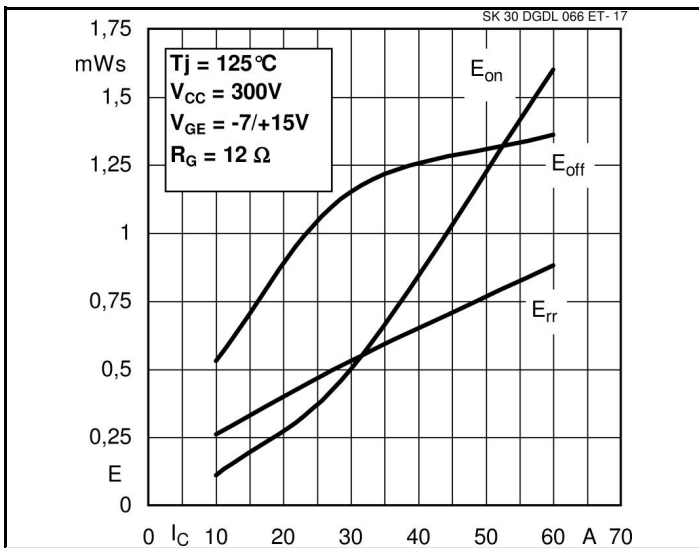

Fig. 17 Turn-on/off energy=f(I_C)

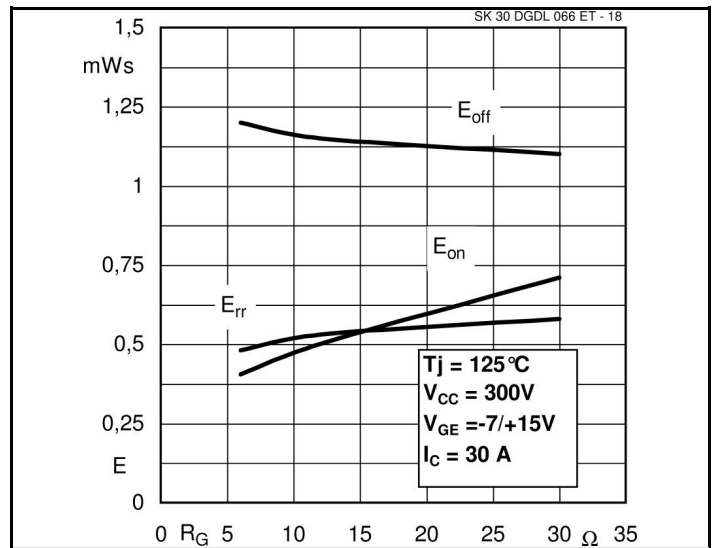

Fig. 18 Turn-on/off energy=f(R_G)

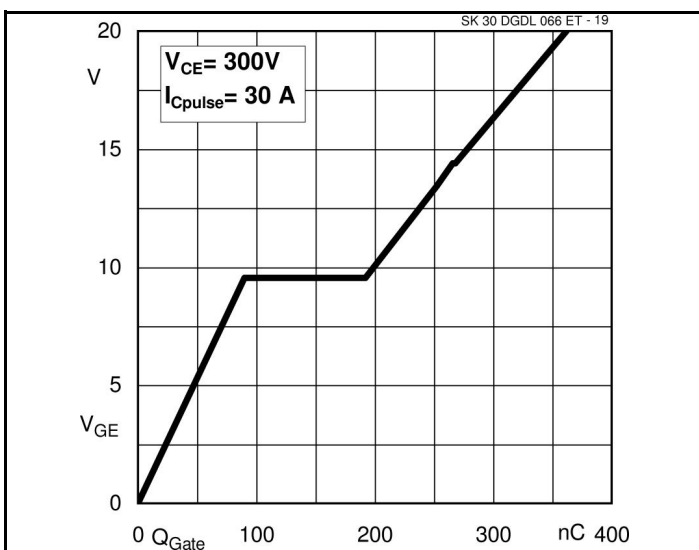
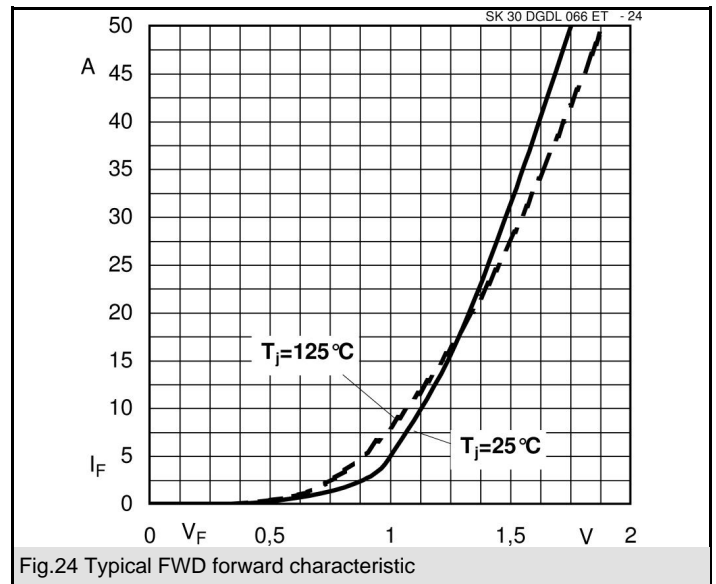
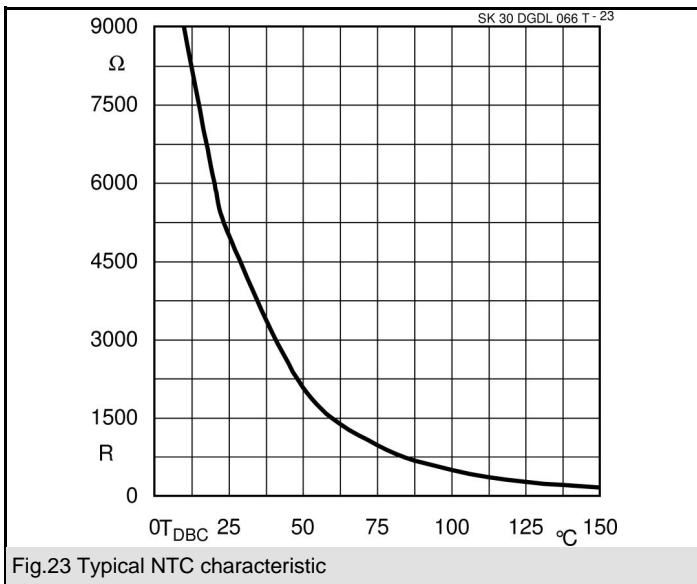
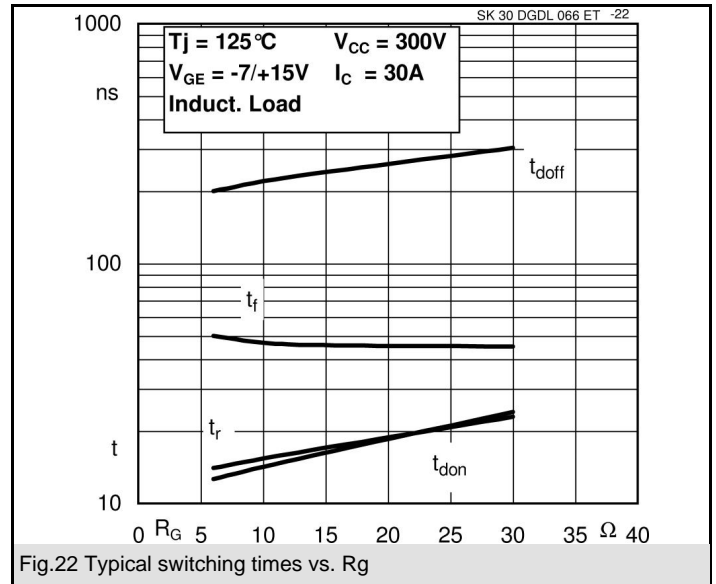
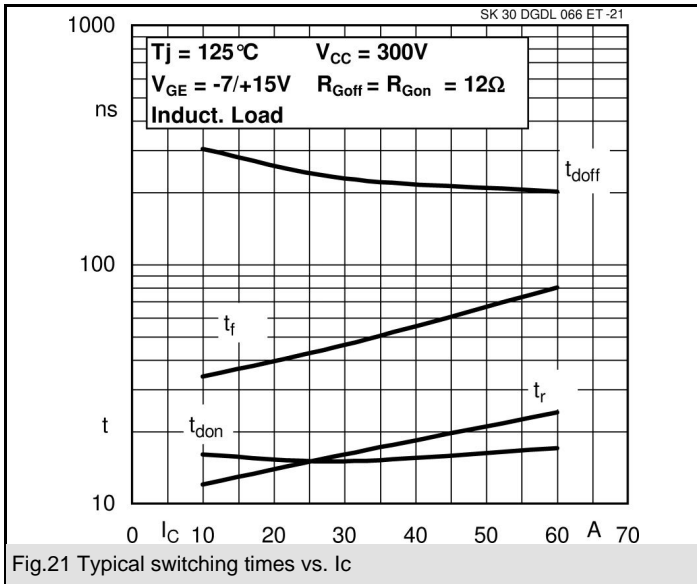
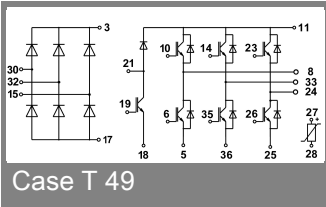

Fig. 19 Typical gate charge characteristic



SK 30 DGDL 066 ET



UL recognized
file no. E 63 532

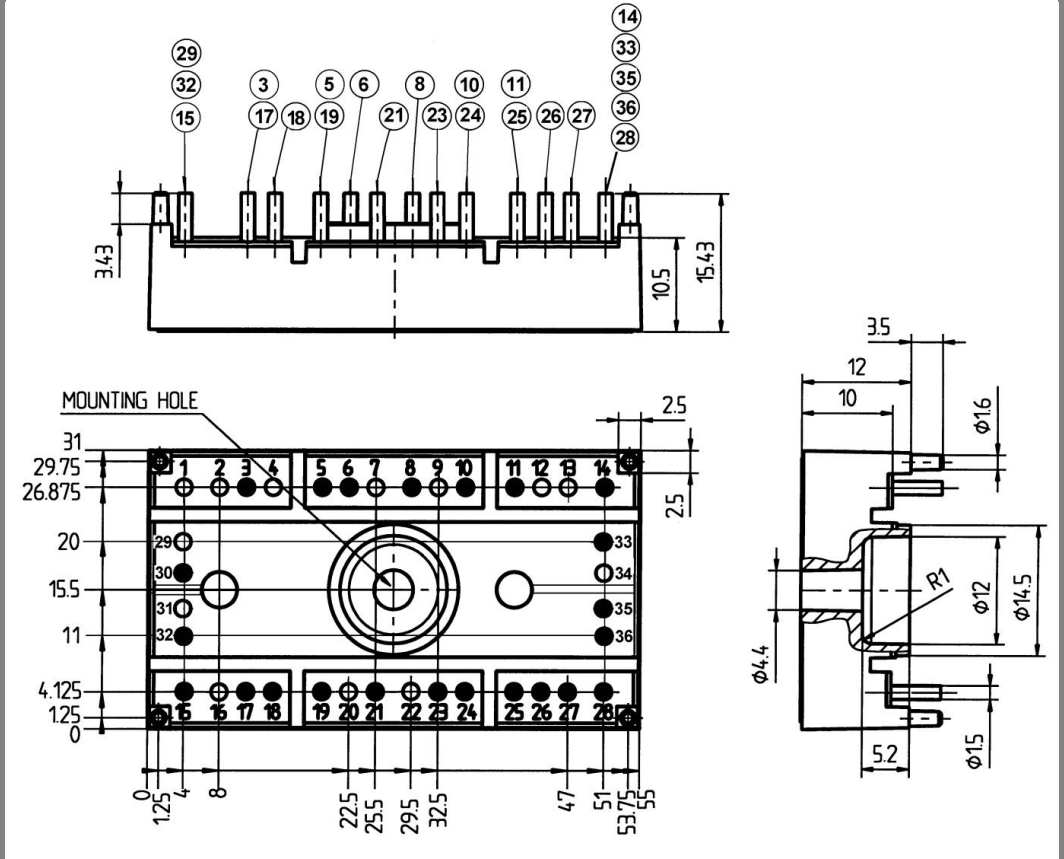

Case T 49 (Suggested hole diameter, in the PCB, for solder pins and plastic mounting pins: 2mm)

This is an electrostatic discharge sensitive device (ESDS), international standard IEC 60747-1, Chapter IX.

This technical information specifies semiconductor devices but promises no characteristics. No warranty or guarantee expressed or implied is made regarding delivery, performance or suitability.